

Please check the examination details below before entering your candidate information

Candidate surname

Other names

Centre Number

Candidate Number

Pearson Edexcel
Level 1/Level 2 GCSE (9–1)

--	--	--	--	--

--	--	--	--	--

Thursday 4 June 2020

Morning (Time: 1 hour 30 minutes)

Paper Reference **1MA1/2H**

Mathematics

Paper 2 (Calculator)

Higher Tier

You must have: Ruler graduated in centimetres and millimetres, protractor, pair of compasses, pen, HB pencil, eraser, calculator. Tracing paper may be used.

Total Marks

Instructions

- Use **black** ink or ball-point pen.
- **Fill in the boxes** at the top of this page with your name, centre number and candidate number.
- Answer **all** questions.
- Answer the questions in the spaces provided – *there may be more space than you need.*
- You must **show all your working**.
- Diagrams are **NOT** accurately drawn, unless otherwise indicated.
- **Calculators may be used.**
- If your calculator does not have a π button, take the value of π to be 3.142 unless the question instructs otherwise.



Information

- The total mark for this paper is 80
- The marks for **each** question are shown in brackets – *use this as a guide as to how much time to spend on each question.*

Advice

- Read each question carefully before you start to answer it.
- Keep an eye on the time.
- Try to answer every question.
- Check your answers if you have time at the end.

Turn over ►

P62278RA

©2020 Pearson Education Ltd.

1/1/1/



P 6 2 2 7 8 R A 0 1 2 4



Pearson

Answer ALL questions.

Write your answers in the spaces provided.

You must write down all the stages in your working.

- 1 (a) Write 84 as a product of its prime factors.

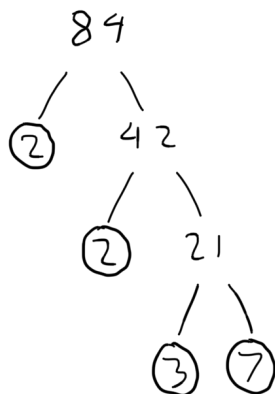

$$2 \times 2 \times 3 \times 7$$

(2)

- (b) Find the lowest common multiple (LCM) of 60 and 84

Multiples of 60:

60, 120, 180, 240, 300, 360, 420

Multiples of 84:

84, 168, 252, 336, 420

$$420$$

(2)

(Total for Question 1 is 4 marks)

DO NOT WRITE IN THIS AREA

DO NOT WRITE IN THIS AREA

DO NOT WRITE IN THIS AREA



DO NOT WRITE IN THIS AREA

DO NOT WRITE IN THIS AREA

DO NOT WRITE IN THIS AREA

- 2 $\mathcal{E} = \{1, 2, 3, 4, 5, 6, 7, 8, 9, 10\}$
 $A = \{\text{even numbers}\}$
 $B = \{\text{factors of } 10\}$

(a) Complete the Venn diagram for this information.

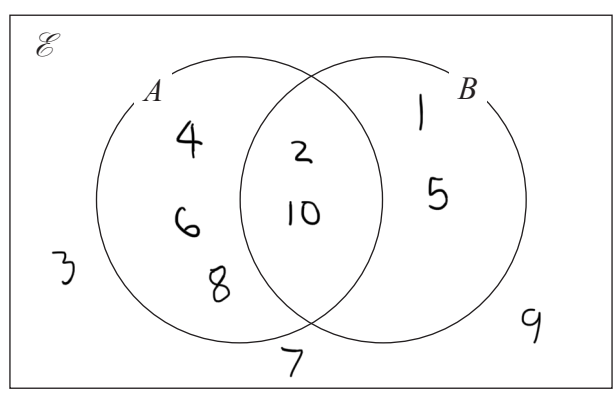

(3)

A number is chosen at random from the universal set, \mathcal{E}

(b) Find the probability that this number is in the set $A \cap B$

$$P(A \cap B) = \frac{2}{10} = 0.2$$

..... 0.2
 (2)

(Total for Question 2 is 5 marks)



3 Carlo puts tins into small boxes and into large boxes.

He puts 6 tins into each small box.

He puts 20 tins into each large box.

Carlo puts a total of 3000 tins into the boxes so that

$$\text{number of tins in small boxes} : \text{number of tins in large boxes} = 2 : 3$$

Carlo says that less than 30% of the boxes filled with tins are large boxes.

Is Carlo correct?

You must show all your working.

$$2 + 3 = 5 \rightarrow 3000 \div 5 = 600$$

$$600 \times 2 = 1200 \quad (\text{small boxes ratio})$$

$$1200 \div 6 = 200$$

$$600 \times 3 = 1800$$

$$1800 \div 20 = 90$$

$$\frac{90}{200+90} = 0.31 = 31\%$$

No as the large boxes make up 31%

(Total for Question 3 is 5 marks)



DO NOT WRITE IN THIS AREA

DO NOT WRITE IN THIS AREA

DO NOT WRITE IN THIS AREA

4 (a) Complete the table of values for $y = 5 - x^3$

x	-2	-1	0	1	2
y	13	6	5	4	-3

(2)

(b) On the grid below, draw the graph of $y = 5 - x^3$ for values of x from -2 to 2

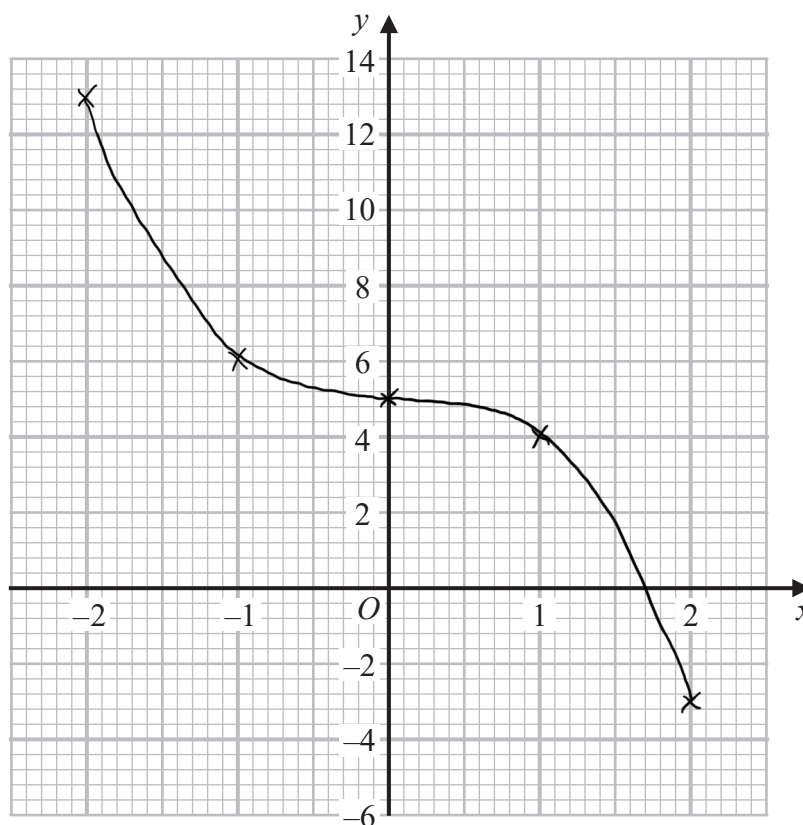

(2)

(Total for Question 4 is 4 marks)



5

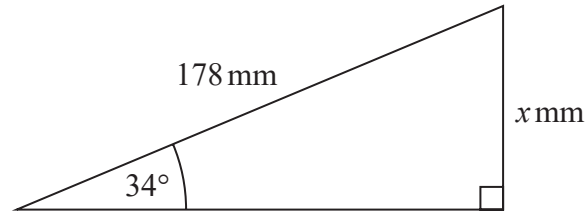

Work out the value of x .
Give your answer correct to 1 decimal place.

$$\sin 34 = \frac{x}{178}$$

$$178 \sin 34 = 99.536$$

$$= 99.5 \text{ mm}$$

99.5

(Total for Question 5 is 2 marks)

6 $\mathbf{a} = \begin{pmatrix} 3 \\ 4 \end{pmatrix}$ $\mathbf{b} = \begin{pmatrix} 5 \\ -2 \end{pmatrix}$

Find $2\mathbf{a} - 3\mathbf{b}$ as a column vector.

$$2\mathbf{a} = 2 \times \begin{pmatrix} 3 \\ 4 \end{pmatrix} = \begin{pmatrix} 6 \\ 8 \end{pmatrix}$$

$$3\mathbf{b} = 3 \times \begin{pmatrix} 5 \\ -2 \end{pmatrix} = \begin{pmatrix} 15 \\ -6 \end{pmatrix}$$

$$2\mathbf{a} - 3\mathbf{b} = \begin{pmatrix} 6 \\ 8 \end{pmatrix} - \begin{pmatrix} 15 \\ -6 \end{pmatrix} = \begin{pmatrix} -9 \\ 14 \end{pmatrix}$$

$$\begin{pmatrix} -9 \\ \dots \\ 14 \end{pmatrix}$$

(Total for Question 6 is 2 marks)

6



P 6 2 2 7 8 R A 0 6 2 4

DO NOT WRITE IN THIS AREA

DO NOT WRITE IN THIS AREA

DO NOT WRITE IN THIS AREA

7 The diagram shows a right-angled triangle and a quarter circle.

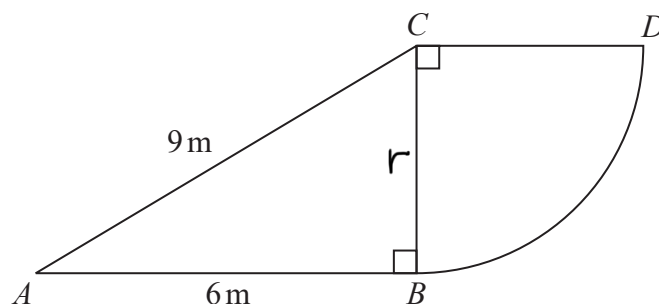

The right-angled triangle ABC has angle $ABC = 90^\circ$
 The quarter circle has centre C and radius CB .

Work out the area of the quarter circle.
 Give your answer correct to 3 significant figures.
 You must show all your working.

$$a^2 + b^2 = c^2$$

$$6^2 + r^2 = 9^2$$

$$r = \sqrt{9^2 - 6^2}$$

$$r = 3\sqrt{5}$$

Area of a circle:

$$\pi r^2 = \pi (3\sqrt{5})^2 = 45\pi$$

Area of a quarter circle:

$$\frac{45\pi}{4} = 35.3429$$

$$= 35.3 \text{ to } 3 \text{ s.f.}$$

..... 35.3 m^2

(Total for Question 7 is 4 marks)



P 6 2 2 7 8 R A 0 7 2 4

8 Tariq buys a laptop.

He gets a discount of 5% off the normal price.

Tariq pays £551 for the laptop.

(a) Work out the normal price of the laptop.

$x = \text{Original price}$

5% off = 95% of original price (0.95)

$$0.95x = 551$$

$$x = 580$$

£ 580
(2)

Joan invests £6000 in a savings account.

The savings account pays compound interest at a rate of

2.4% for the first year

1.7% for each extra year.

(b) Work out the value of Joan's investment at the end of 3 years.

$$1^{\text{st}} \text{ Year: } 6000 \times 1.024 = 6,144$$

$$2^{\text{nd}} \text{ \& } 3^{\text{rd}} \text{ Years: } 6,144 \times (1.017)^2 = 6354.67$$

£ 6354.67
(3)

(Total for Question 8 is 5 marks)



DO NOT WRITE IN THIS AREA

DO NOT WRITE IN THIS AREA

DO NOT WRITE IN THIS AREA

9 Aisha recorded the heights, in centimetres, of some girls. She used her results to work out the information in this table.

Least height	142 cm
Lower quartile	154 cm
Interquartile range	17 cm
Median	162 cm
Range	40 cm

Aisha drew this box plot for the information in the table. The box plot is **not** fully correct.

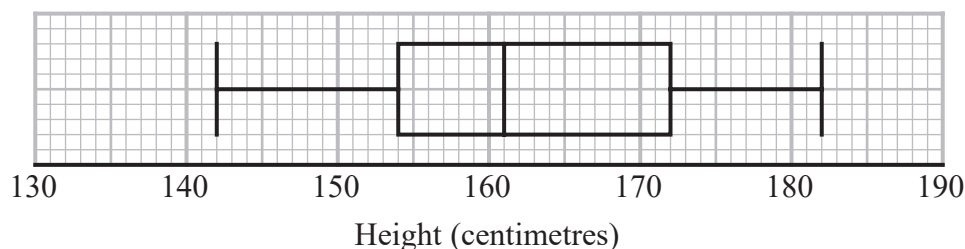

Write down the two things Aisha should do to make the box plot fully correct.

1 The median is drawn incorrectly, it needs to be at 162 cm.

2 The range is 17, yet the upper quartile is drawn incorrectly at 172 cm, it needs to be drawn at 171 cm instead.

(Total for Question 9 is 2 marks)



10 (a) Simplify $\left(\frac{1}{m^2}\right)^0$

$$\frac{1}{\dots\dots\dots}$$

(1)

(b) Simplify $\frac{8(x-4)}{(x-4)^2} = \frac{8}{(x-4)}$

$$\frac{8}{x-4}$$

(1)

(c) Simplify $(3n^4w^2)^3$

$$\begin{aligned} (3n^4w^2)^3 &= (3)^3 \times (n^4)^3 \times (w^2)^3 \\ &= 27 \times n^{12} \times w^6 \\ &= 27n^{12}w^6 \end{aligned}$$

$$\frac{27n^{12}w^6}{\dots\dots\dots}$$

(2)

(Total for Question 10 is 4 marks)

11 Jack is in a restaurant.

There are 5 starters, 8 main courses and some desserts on the menu.

Jack is going to choose one starter, one main course and one dessert.

He says there are 240 ways that he can choose his starter, his main course and his dessert.

Could Jack be correct?

You must show how you get your answer.

$$240 \div 5 = 48$$

$$48 \div 8 = 6$$

Yes he is correct

(Total for Question 11 is 2 marks)



DO NOT WRITE IN THIS AREA

DO NOT WRITE IN THIS AREA

DO NOT WRITE IN THIS AREA

12 The graph gives information about the volume, v litres, of petrol in the tank of Jim's car after it has travelled a distance of d kilometres.

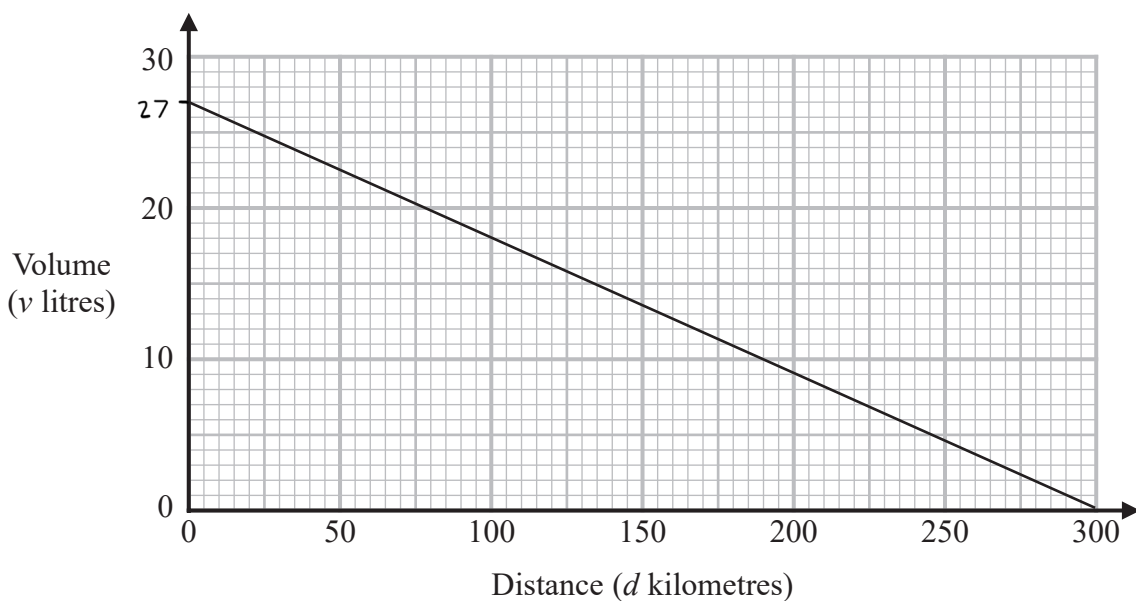

(a) Find the gradient of the graph.

$$\frac{\Delta y}{\Delta x} = \text{gradient} = \frac{0 - 27}{300 - 0} = -0.09$$

$$\frac{-0.09}{(2)}$$

(b) Interpret what the gradient of the graph represents.

For every 1 kilometre travelled, the volume of fuel decreases by 0.09 litres.

(1)

(Total for Question 12 is 3 marks)



13 Here is triangle ABC .

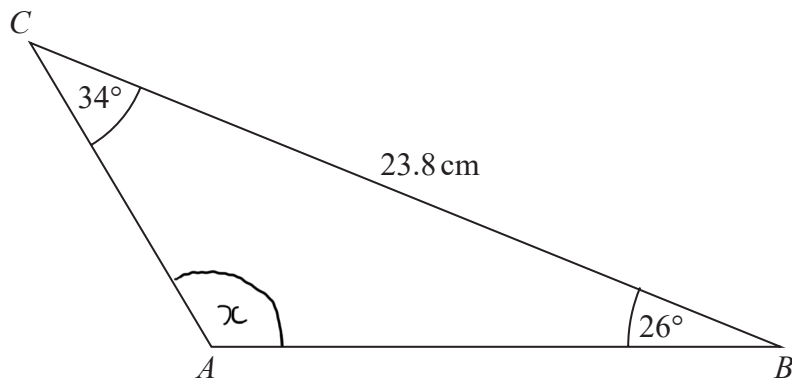

Work out the length of AB .
Give your answer correct to 1 decimal place.

Angles in a triangle add up to 180° :

$$\begin{aligned}x + 26^\circ + 34^\circ &= 180^\circ \\x &= 120^\circ\end{aligned}$$

$$\text{Sine Rule: } \frac{23.8}{\sin 120} = \frac{AB}{\sin 34}$$

$$AB = \frac{23.8 \times \sin 34}{\sin 120}$$

$$\begin{aligned}AB &= 15.368 \text{ cm} \\&= 15.4 \text{ cm}\end{aligned}$$

..... 15.4 cm

(Total for Question 13 is 3 marks)

DO NOT WRITE IN THIS AREA

DO NOT WRITE IN THIS AREA

DO NOT WRITE IN THIS AREA



DO NOT WRITE IN THIS AREA

DO NOT WRITE IN THIS AREA

DO NOT WRITE IN THIS AREA

14 Here are two squares, A and B.

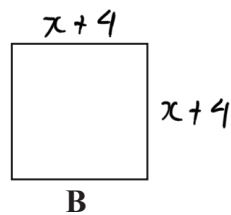
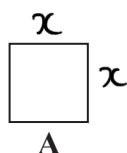

The length of each side of square B is 4 cm greater than the length of each side of square A.
The area of square B is 70 cm^2 greater than the area of square A.

Find the area of square B.

Give your answer correct to 3 significant figures.

You must show all your working.

$$\text{Area of A: } x \times x = x^2$$

$$\text{Area of B: } (x+4) \times (x+4) = x^2 + 8x + 16$$

$$\begin{array}{r} x^2 + 8x + 16 = x^2 + 70 \\ -x^2 - 70 \quad \swarrow \quad \searrow \\ \hline 8x - 54 = 0 \\ 8x = 54 \\ x = 6.75 \end{array}$$

$$\begin{aligned} \text{Area of B: } (6.75)^2 + 8(6.75) + 16 &= 115.5625 \\ &= 116 \text{ to 3 s.f.} \end{aligned}$$

.....116..... cm^2

(Total for Question 14 is 4 marks)



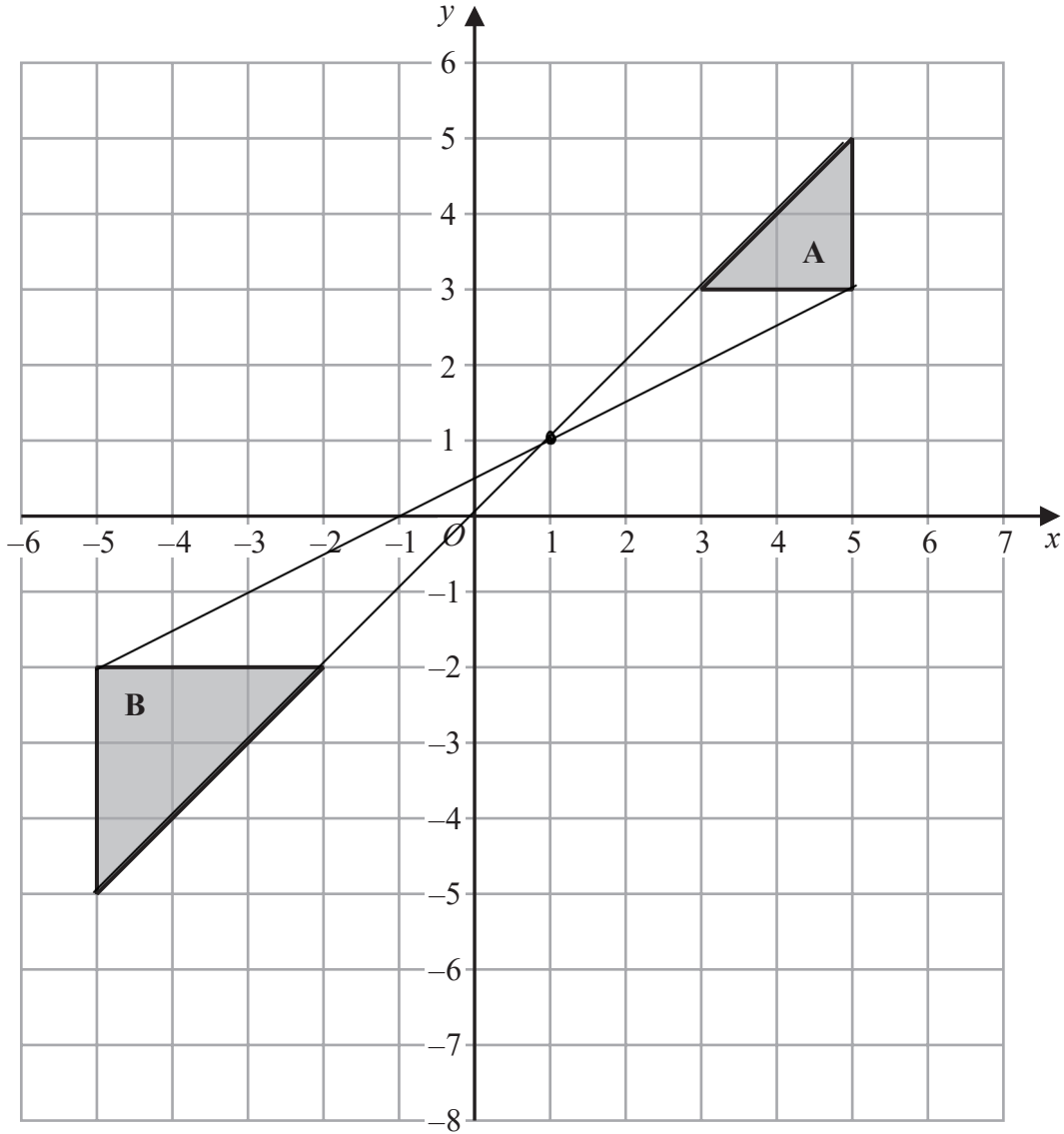

Describe fully the single transformation that maps triangle A onto triangle B.

An enlargement of -1.5 around point $(1, 1)$.

(Total for Question 15 is 2 marks)



DO NOT WRITE IN THIS AREA

16 Here are the first five terms of a quadratic sequence.

10 21 38 61 90

Find an expression, in terms of n , for the n th term of this sequence.

Prev. Value

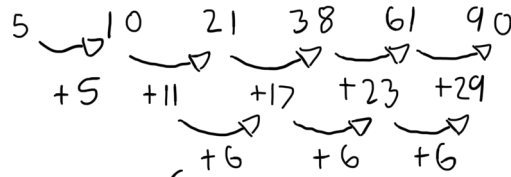

$$6 \div 2 = 3$$

3 is the coefficient of n^2 .

$$3n^2 + 2n + 5$$

$$3n^2 = 3, 12, 27, 48, 75$$

$$\text{sequence} = 10 \quad 21 \quad 38 \quad 61 \quad 90$$

$$\text{Difference} = 7 \quad 9 \quad 11 \quad 13 \quad 15$$

+2 +2 +2 +2

Difference is n : 1 2 3 4 5

2. Find values $2n$: 2 4 6 8 10

For $2n$. $2n+5$: 7 9 11 13 15

↓
Add 5 to get
back to the sequence
before.

$$3n^2 + 2n + 5$$

(Total for Question 16 is 3 marks)

17 Write down the coordinates of the turning point on the graph of $y = (x + 12)^2 - 7$

(-12 , -7)

(Total for Question 17 is 1 mark)

DO NOT WRITE IN THIS AREA

DO NOT WRITE IN THIS AREA



18 The diagram represents a solid cone.

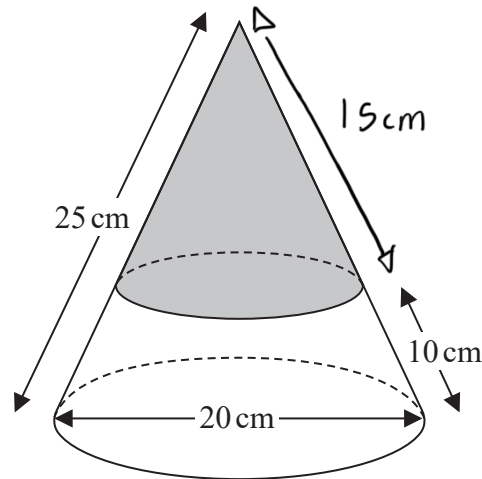

Curved surface area of cone = $\pi r l$

The cone has a base diameter of 20 cm and a slant height of 25 cm.

A circle is drawn around the surface of the cone at a slant height of 10 cm above the base. The curved surface of the cone above the circle is painted grey.

Work out the area of the curved surface of the cone that is **not** painted grey.
Give your answer as a multiple of π
You must show all your working.

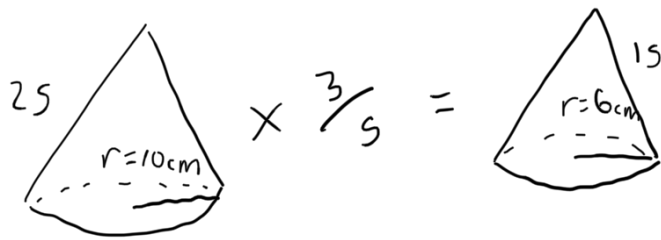

↓

Surface Area:

$$\pi \times 10 \times 25$$

$$= 250\pi$$

↓

Surface Area:

$$\pi \times 6 \times 15$$

$$= 90\pi$$

$$250\pi - 90\pi = 160\pi$$

.....160π..... cm²

(Total for Question 18 is 4 marks)

DO NOT WRITE IN THIS AREA

DO NOT WRITE IN THIS AREA

DO NOT WRITE IN THIS AREA



DO NOT WRITE IN THIS AREA

DO NOT WRITE IN THIS AREA

DO NOT WRITE IN THIS AREA

19 A hot air balloon is descending.

The height of the balloon n minutes after it starts to descend is h_n metres.

The height of the balloon $(n + 1)$ minutes after it starts to descend, h_{n+1} metres, is given by

$$h_{n+1} = K \times h_n + 20 \text{ where } K \text{ is a constant.}$$

The balloon starts to descend from a height of 1200 metres at 09 15

At 09 16 the height of the balloon is 1040 metres.

Work out the height of the balloon at 09 18

$$1040 = 1200K + 20$$

$$1020 = 1200K$$

$$K = 0.85$$

$$0917 : 0.85(1040) + 20 = 904$$

$$0916 : 0.85(904) + 20 = 788.4 \text{ m}$$

..... 788.4 m

(Total for Question 19 is 4 marks)



20 There are only red sweets and yellow sweets in a bag.

There are n red sweets in the bag.

There are 8 yellow sweets in the bag.

Sajid is going to take at random a sweet from the bag and eat it.

He says that the probability that the sweet will be red is $\frac{7}{10}$

(a) Show why the probability cannot be $\frac{7}{10}$

$$\frac{n}{n+8} = \frac{7}{10} \rightarrow \begin{aligned} 10n &= 7(n+8) \\ 10n &= 7n+56 \\ 3n &= 56 \\ n &= \frac{56}{3} \end{aligned}$$

← Not an integer
∴ Not possible

(3)

After Sajid has taken the first sweet from the bag and eaten it, he is going to take at random a second sweet from the bag.

Given that the probability that both the sweets he takes will be red is $\frac{3}{5}$

(b) work out the number of red sweets in the bag.

You must show all your working.

1 st Pick	2 nd Pick
$\frac{n}{n+8}$	$\frac{n-1}{n+7}$

$$\frac{n}{n+8} \times \frac{n-1}{n+7} = \frac{n(n-1)}{(n+8)(n+7)} = \frac{3}{5}$$

$$\frac{n^2 - n}{n^2 + 15n + 56} = \frac{3}{5}$$

$$5n^2 - 5n = 3n^2 + 45n + 168$$

$$2n^2 - 50n - 168 = 0$$

$$n^2 - 25n - 84 = 0$$

(Quadratic Formula)

$$n = \frac{-(-25) \pm \sqrt{(-25)^2 - 4(1)(-84)}}{2 \times 1}$$

$$n = -3 \text{ or } 28$$

Not possible



DO NOT WRITE IN THIS AREA

DO NOT WRITE IN THIS AREA

DO NOT WRITE IN THIS AREA

28

(5)

(Total for Question 20 is 8 marks)



21 The graph of the curve with equation $y = f(x)$ is shown on the grid below.

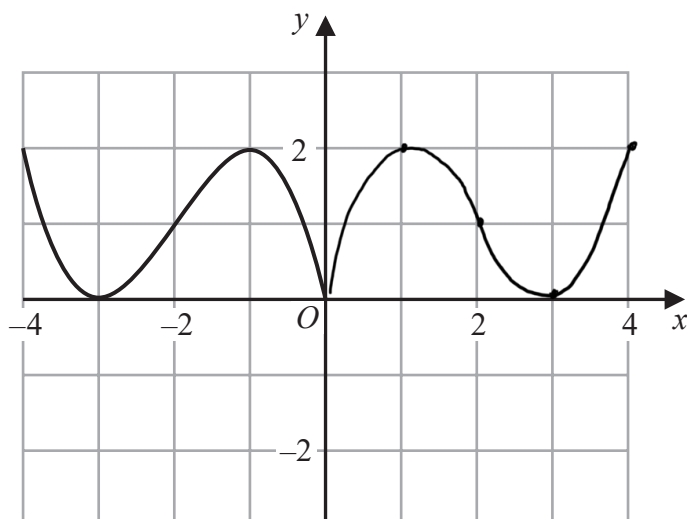

(a) On the grid above, sketch the graph of the curve with equation $y = f(-x)$

(2)

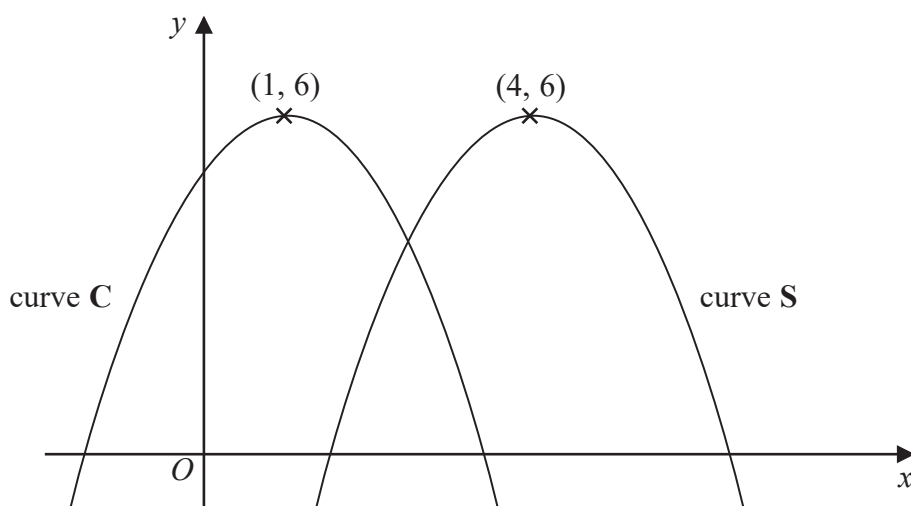

The curve C with equation $y = 5 + 2x - x^2$ is transformed by a translation to give the curve S such that the point (1, 6) on C is mapped to the point (4, 6) on S.

(b) Find an equation for S.

$$y_c = -x^2 + 2x + 5 = F(x)$$

shifted to the right 3

$$F(x-3) = -(x-3)^2 + 2(x-3) + 5$$

$$= -(x^2 - 6x + 9) + 2x - 6 + 5$$

$$= -x^2 + 6x - 9 + 2x - 6 + 5$$

$$\rightarrow = -x^2 + 8x - 10$$

$$-x^2 + 8x - 10$$

(2)

(Total for Question 21 is 4 marks)



DO NOT WRITE IN THIS AREA

22 C is a circle with centre the origin.

A tangent to C passes through the points $(-20, 0)$ and $(0, 10)$

Work out an equation of C.

You must show all your working.

$$\text{Tangent gradient: } \frac{10-0}{0-(-20)} = \frac{1}{2}$$

$$\text{Normal gradient: } -\frac{1}{(\frac{1}{2})} = -2$$

$$\text{Equation of line: } y = \frac{1}{2}x + 10$$

$$\frac{1}{2}x + 10 = -2x$$

$$\text{When } x = -4$$

$$y = \frac{1}{2}x + 10$$

$$y = \frac{1}{2}(-4) + 10 = 8$$

$$x^2 + y^2 = (-4)^2 + (8)^2$$

$$x^2 + y^2 = 16 + 64$$

$$x^2 + y^2 = 80$$

$$x^2 + y^2 = 80$$

(Total for Question 22 is 5 marks)

TOTAL FOR PAPER IS 80 MARKS



DO NOT WRITE IN THIS AREA

DO NOT WRITE IN THIS AREA

DO NOT WRITE IN THIS AREA

BLANK PAGE



DO NOT WRITE IN THIS AREA

DO NOT WRITE IN THIS AREA

DO NOT WRITE IN THIS AREA

BLANK PAGE



DO NOT WRITE IN THIS AREA

DO NOT WRITE IN THIS AREA

DO NOT WRITE IN THIS AREA

BLANK PAGE

